

PART NAME

ALUMINUM INSTRUMENT CASE

PART No.

IA-6163

REVISION DATE

-

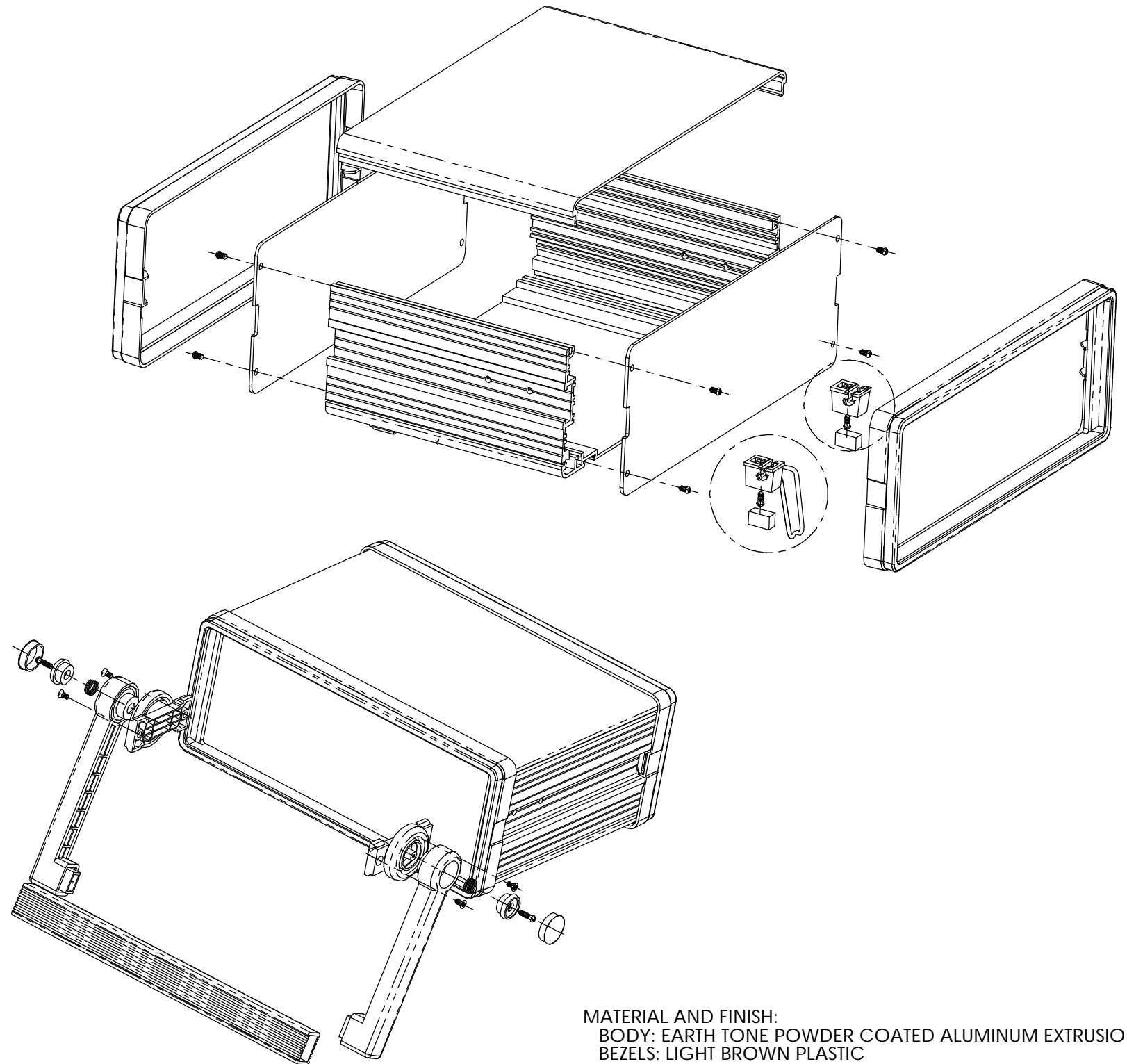
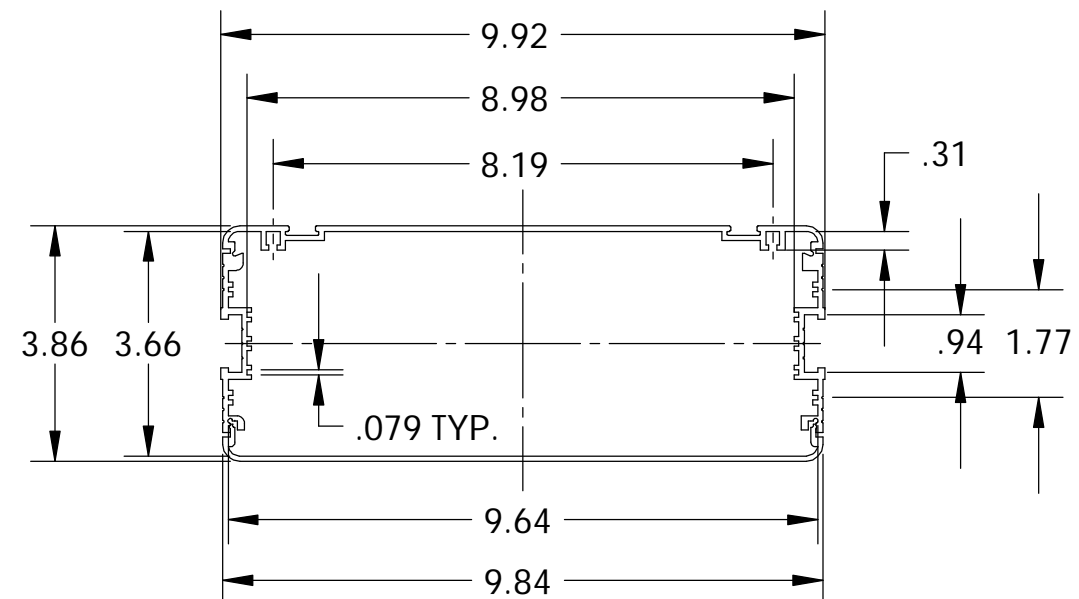
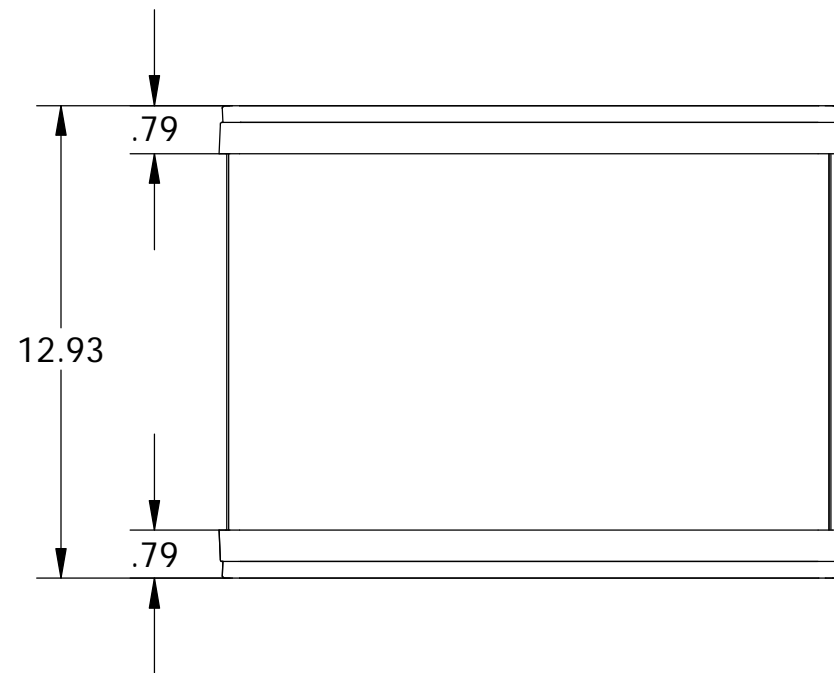
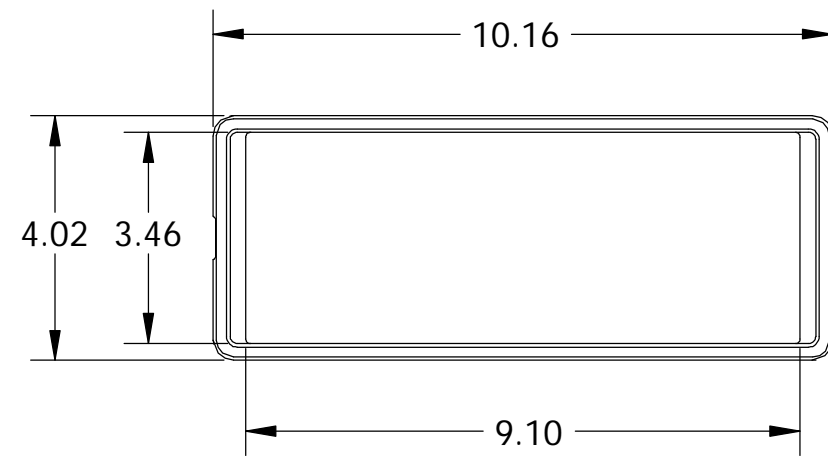

MATERIAL AND FINISH:
 BODY: EARTH TONE POWDER COATED ALUMINUM EXTRUSION
 BEZELS: LIGHT BROWN PLASTIC
 PANELS: NATURAL ALUMINUM
 HANDLE: LIGHT GRAY PLASTIC/ANODIZED ALUMINUM EXTRUSION

DIMENSIONS ARE IN INCHES